

EYWA: An established Early Warning System to Address World Wide Epidemics Crisis caused by the Mosquito Borne Diseases

Haris Kontoes
Research Director
(BEYOND Centre | IAASARS | NOA)
On behalf of EYWA team



<http://beyond-eocenter.eu/>



Winner of the first "EIC Horizon Prize
on Early Warning for Epidemics"

Introduction | A global problem

- ❑ **Climate Change, globalisation** and other drivers are altering ecological conditions for **mosquitoes**.
- ❑ Mosquito-Borne Diseases (MBDs) are present in **over 100 countries**.
- ❑ 700,000 deaths per year.
- ❑ **Malaria**, most lethal for kids aged under five in the sub-Saharan regions.
- ❑ **Europe** a “hot spot” of **West Nile Virus**.
- ❑ **Chikungunya** and **dengue fever** increased 40% over 1950¹.

1. [https://www.thelancet.com/action/showPdf?pii=S0140-6736\(20\)32290-X](https://www.thelancet.com/action/showPdf?pii=S0140-6736(20)32290-X)

Working towards a solution

- ❑ **Need to control this threat** gave birth to the **EYWA** early warning system.
- ❑ **EYWA**: outcome of a 4-year voluntary action.
- ❑ **Vision**: EYWA as a **key tool** to the epidemics arsenal.

- ❑ **State of the art tool guiding:**
 - **Vector preventive/control actions**
 - **Targeted door-to-door awareness**

- ❑ **Diverse domains of expertise:**
 - **Earth Observation,**
 - **Advanced epidemiological and entomological modeling,**
 - **Artificial Intelligence/Machine Learning, Big data analytics.**

Working towards a solution

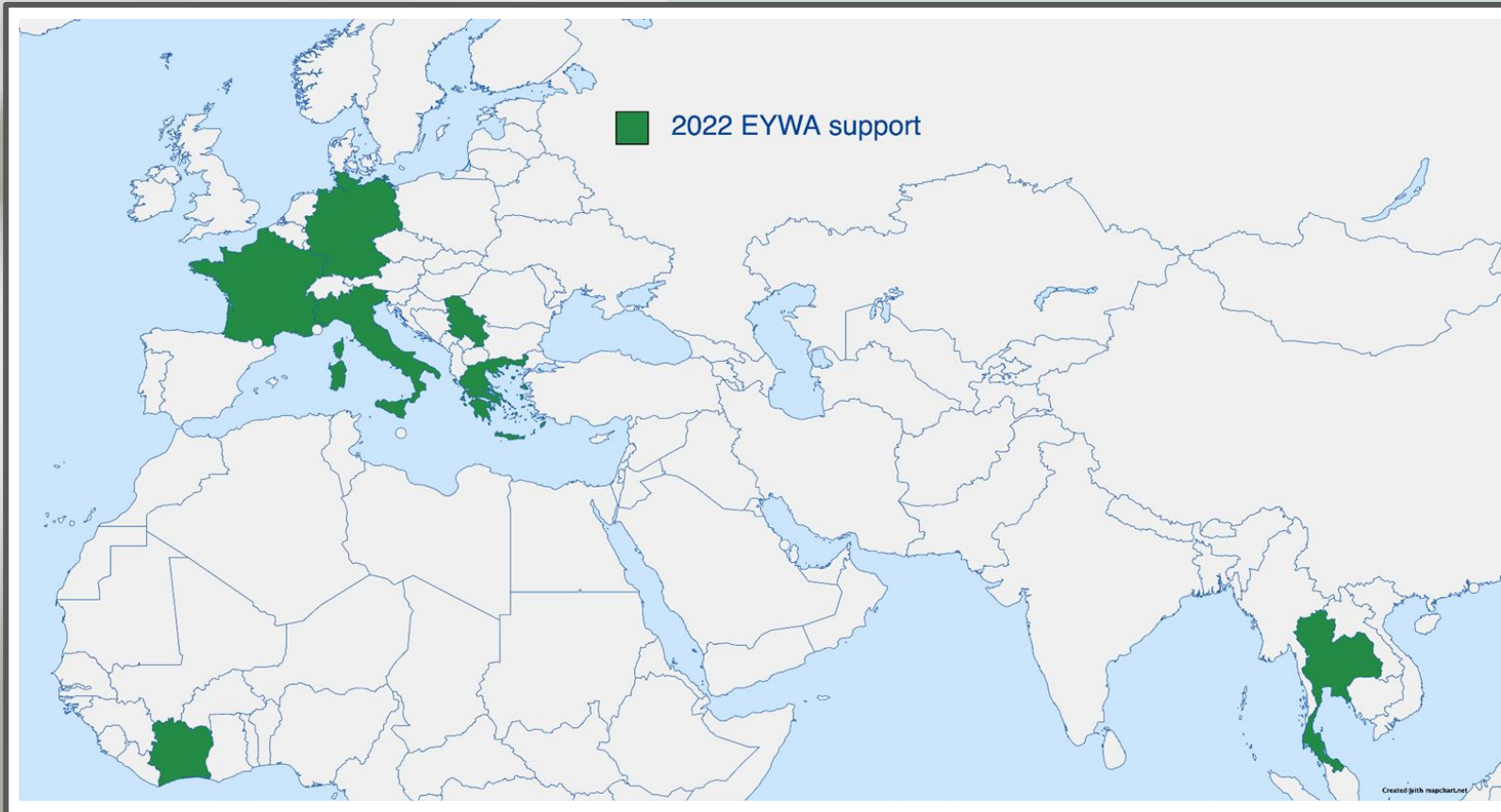

- ❑ After three years of developments the system started its operation in **2020**.
- ❑ Predictions were provided for **4 regions** in **Greece** and **1 region** in **Italy**.
- ❑ In **2021** the system **expanded** to a total of **10 regions** in **5 European countries (France, Germany, Greece, Italy, Serbia)**.
- ❑ Joining the e-shape Horizon 2020 project, EYWA expanded to **Cote d'Ivoire** and **Thailand**.
- ❑ Following up on this in **2022** the system expanded to provide predictions in **Ivory Coast** in **Africa** and **Thailand** in **Asia**.
- ❑ Additionally the **Trento** region in **Italy** was integrated bring the total number of regions to 17.

A fragmented landscape

Before EYWA:

- Entomological & epidemiological data siloed in individual repositories
- No uniformity in data

- Lack of:**
 - **Environment, weather conditions, geomorphological, landscape, statistical information collected and cleaned**
 - **Standardization for feature selection and engineering approaches to feed AI/Dynamic models**
- No robust and transferable AI solutions**

EYWA set the stage for:

- Data centralization in a common database
- Automatic generation of statistical features of the environment and weather around collection sites.
- Quality assurance & control

System Evolution

Mosquito Collections Stored

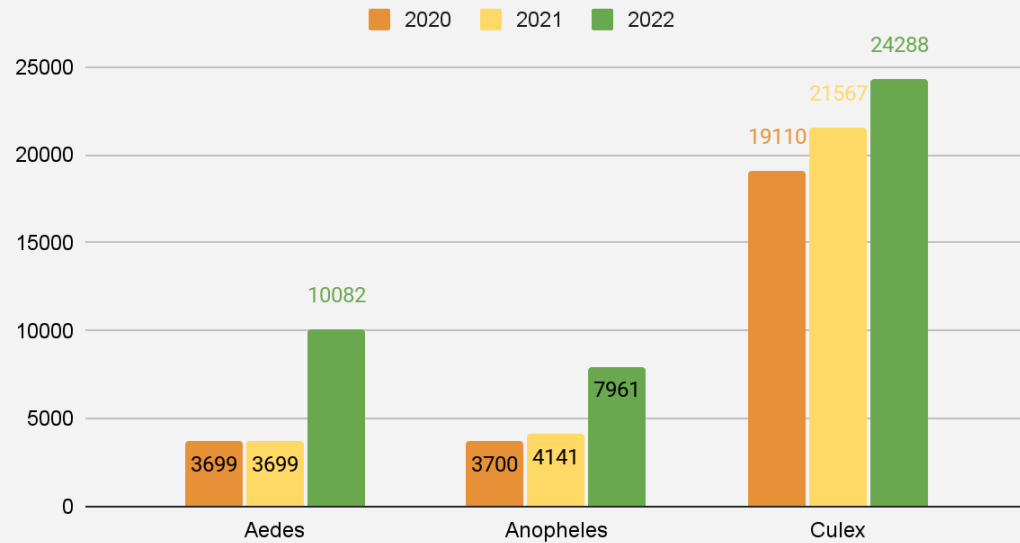

EYWA Operational Support

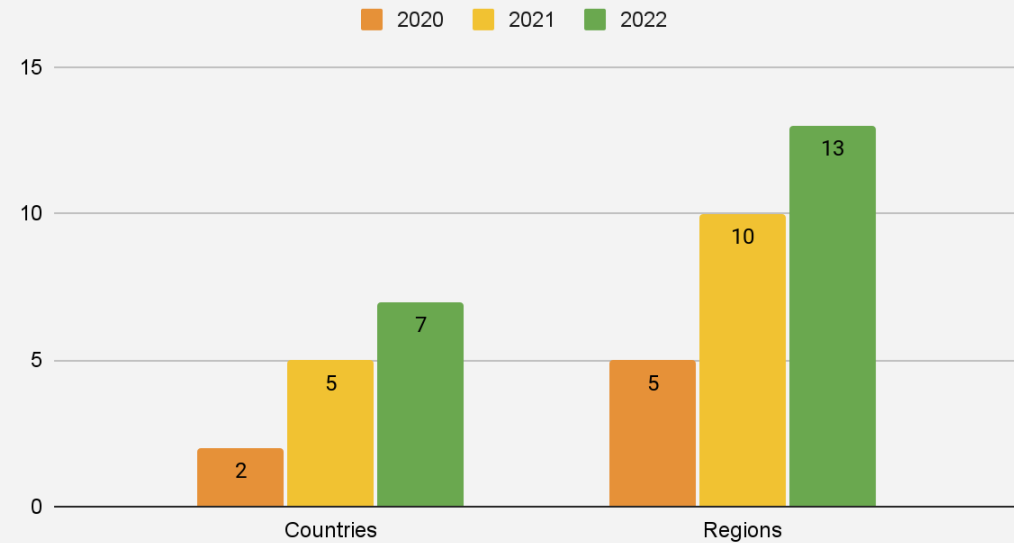

Making it work

The EYWAarchitecture

- ❑ Time-series entomological, epidemiological, socio-economic, satellite Earth Observation, meteorological and geomorphological data
- ❑ 36 features for each of the 42.400 mosquito collections in our database.
- ❑ A “MAMOTH” feature space **12-years time series of data** for mosquito-traps network in **11 regions in Europe** and **2 in Africa & Asia**.
- ❑ Processing more than **33 TB** of Earth Observation data to generate them.
- ❑ **Environment proxies** (Sentinel 2, Landsat 7/8):
 - Normalized Difference Vegetation Index (**NDVI**)
 - Normalized Difference Moisture Index (**NDMI**)
 - Normalized Difference Water Index (**NDWI**)
 - Normalized Difference Build-Up Index (**NDBI**)
- ❑ **Meteorological Data** (Copernicus ERA-5, MODIS, IMERG):
 - Wind, Land Surface Temperature (**LST**), Rainfall
- ❑ **Geomorphological Data** (Alos Palsar, Copernicus Water & Wetness):
 - Elevation, Aspect, Slope
 - Composite features

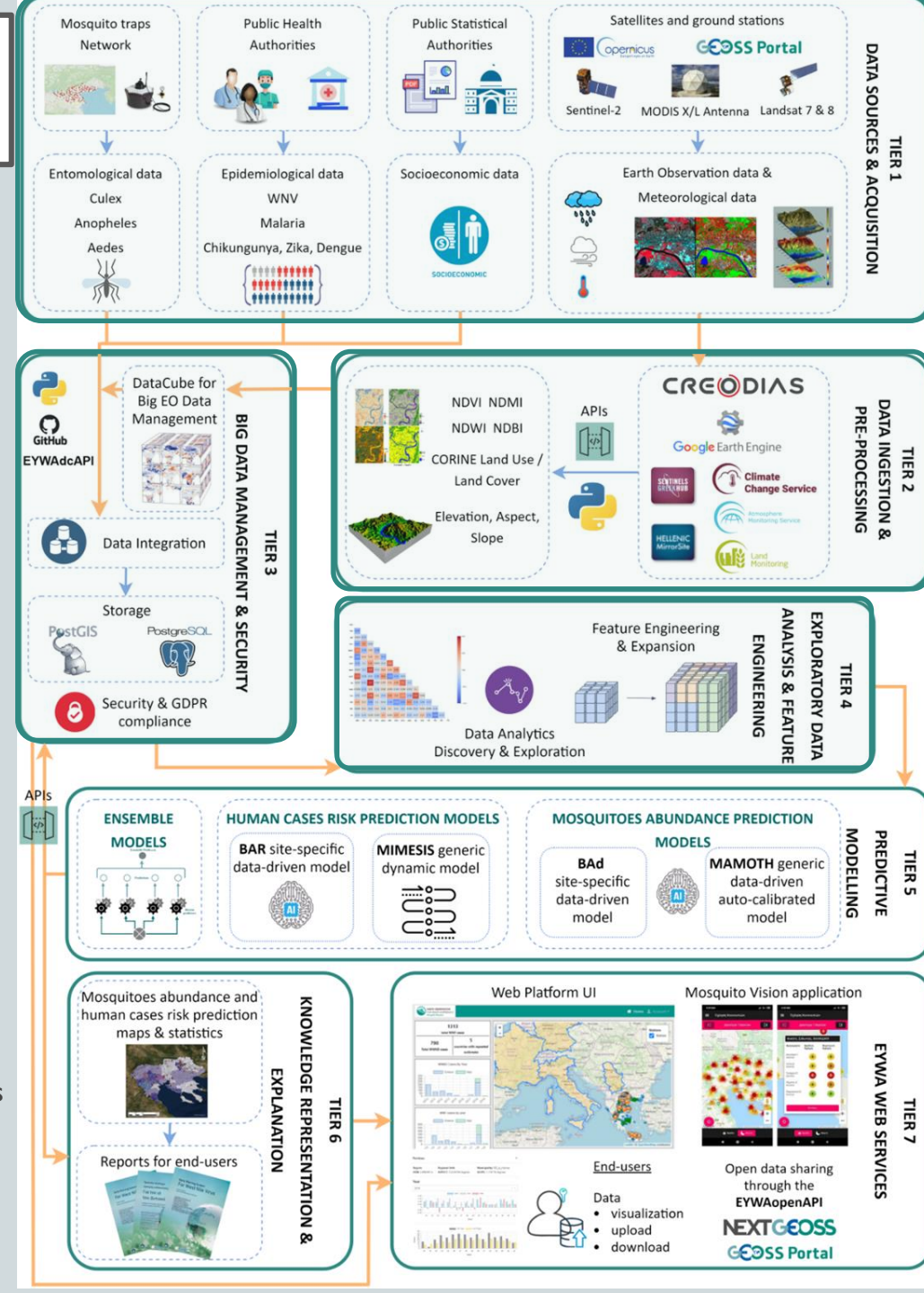

MIMESIS

MIMESIS (spatial dynaMical Model for wEST Nile virus)

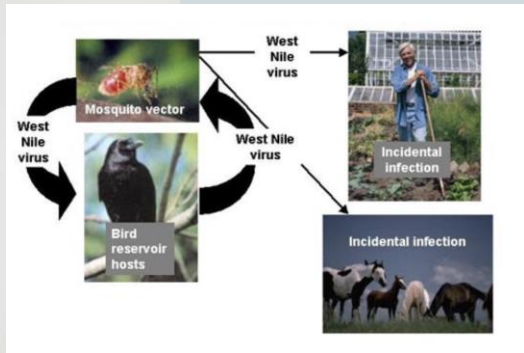
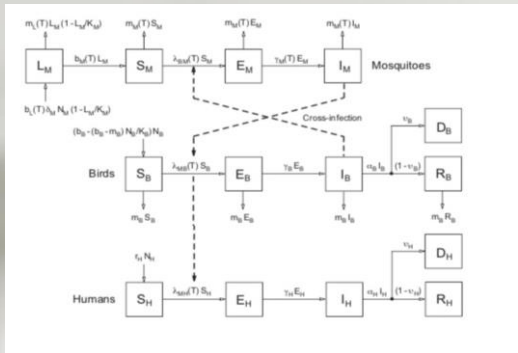

- ❑ Developed by the Laboratory of Atmospheric Physics of the University of Patras.
- ❑ Climate dependent epidemiological (deterministic) model that works on a ensemble probabilistic frame that provides West Nile Virus risk maps.
- ❑ The model operates spatially at the meso-scale and temporarily at the monthly to seasonal scale.
- ❑ Supports 4 regions in Greece and 1 region in Italy.
- ❑ Average detection probability exceeds 74% (reforcasts).
- ❑ During the 2022 operational season:
 - ❑ In April, in the region of Central Macedonia the model predicted 11 municipalities as high risk areas of registering WNV cases.
 - ❑ In 10 of those cases were later indeed registered (91% accuracy).

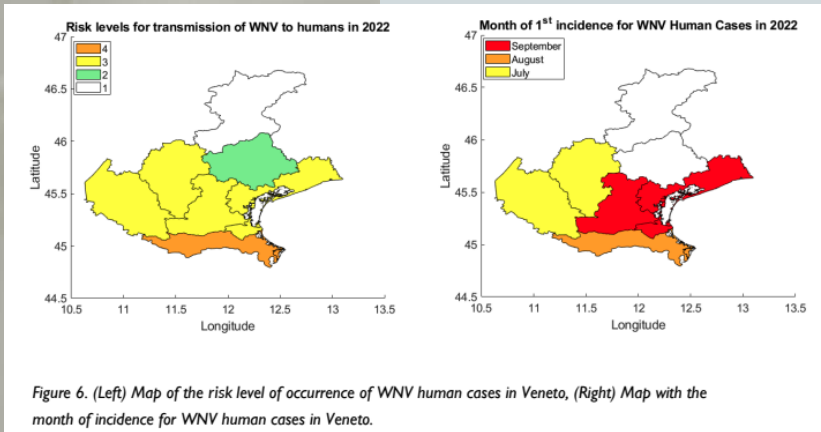
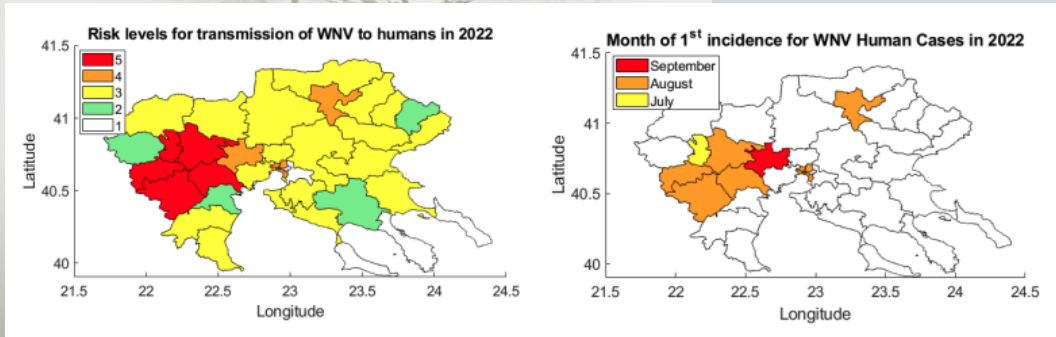

Figure 6. (Left) Map of the risk level of occurrence of WNV human cases in Veneto, (Right) Map with the month of incidence for WNV human cases in Veneto.

BAd & BAR

BAd (Big data technologies' model for Adult mosquitoes)

BAR22 (Big Data Technologies model for the Assessment of Risk)

- Developed by Ecodevelopment S.A.
- Daily forecasts of mosquito abundance on a settlement level.
- Available in 4 regions in Greece.
- Outputs 10 equiprobable classes of populations
- A data driven regression machine learning model, using the XGBoost implementation of the boosted trees algorithm.
- Trained using data from 11.138 mosquito collections.
- It is fed with another model that provides predictions on mosquito larvae.
- The model accuracy is calculated with the Mean Absolute Error, and the validation error has been calculated to 1.27 classes.
- Powers the Mosquito Vision app that provides the model output as nuisance level available in more than 2400 settlements.

- Developed by Ecodevelopment S.A.
- Weekly forecasts of West Nile Virus risk on a settlement level.
- A data driven neural network model.
- Outputs risk on 5 levels (0-4, very low to very high)
- Available in the Central Macedonia region.
- Supports larviciding actions.
- Updated version of the older BAR model works on providing predictions on zones of settlements.
- Operational since 1st August 2022.
- For 46 out of 54 zones (covering 888 settlements) the risk level was off by 1 level on average for cases registered in the August/September period, for an accuracy of 85%.

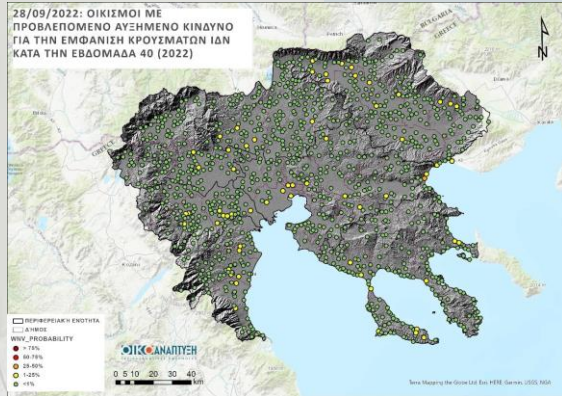

BAR22 predictions
Settlement level WNV risk

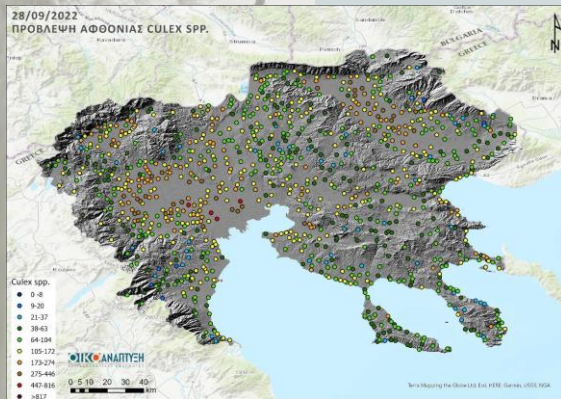

BAd predictions
Culex Mosquito Abundance



Mosquito Vision app
BAd predictions / nuisance levels

MAMOTH

MAMOTH (Mosquitoes **A**bundance prediction **M**odel auto-calibrated from features ple**T**Hora)

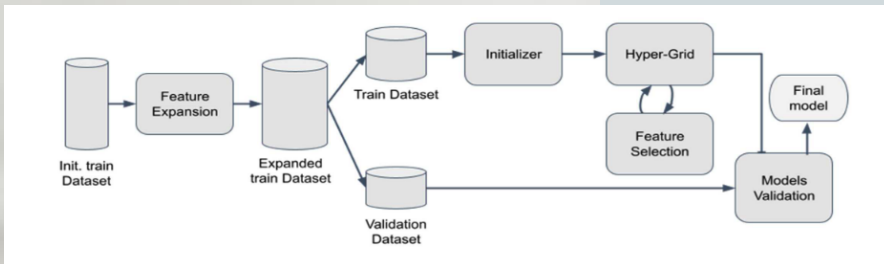

Model Training Pipeline

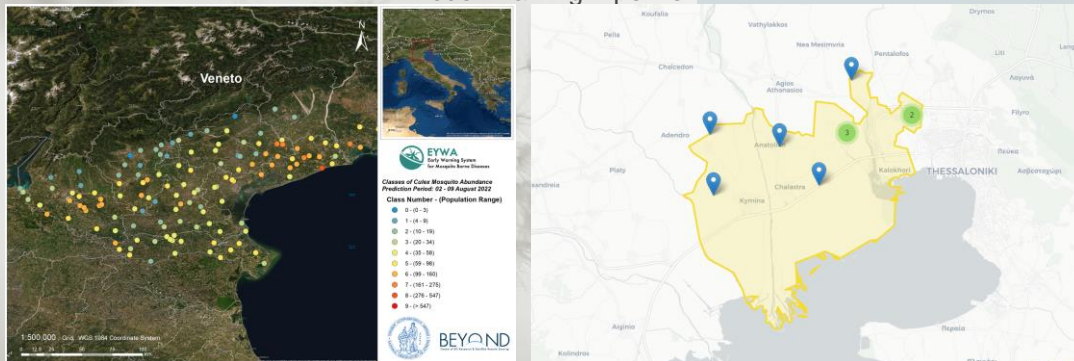

Operational predictions
(Veneto region)

Mosquito abundance aggregate statistics
(color represents mean value)
Delta municipality, Central Macedonia

**Robustness, Scalability,
Transferability, Site and
Mosquito type agnostic,
Transfer Learning
capability**

- ❑ Data driven model, developed by the Beyond Operational Unit of the IAASARS/National Observatory of Athens using the 12-year series of tabular entomological data (42.400 collections) from multiple countries, based on the xgboost algorithm.
- ❑ The model takes as input all available entomological data and the EO generated features in each region & species, and using a train/validation pipeline selects the best features, then predicts the expected mosquito population on any point for the next 15-30 days (customizable).
- ❑ Works with the Aedes, Anopheles & Culex mosquitoes in all EYWA supported countries, supporting all mosquito-borne diseases.
- ❑ Accuracy of > 93% in predicting high/medium/low risk of mosquitoes.
- ❑ Implementation available to provide complete entomological risk map of a whole region in a 2x2km grid.
- ❑ Has been extended to provide area level (province / municipality / settlement) aggregate statistics of mosquito populations, by sampling the area of interest to generate random points then predicting for each point and aggregating.
- ❑ Work is being undertaken for the MAMOTH model to feed predictions on a municipality level (aggregate statistics) into the MIMESIS model beginning in the coming 2023 operational season.

MAMOTH



Mosquito abundance
Abidjan, Ivory Coast

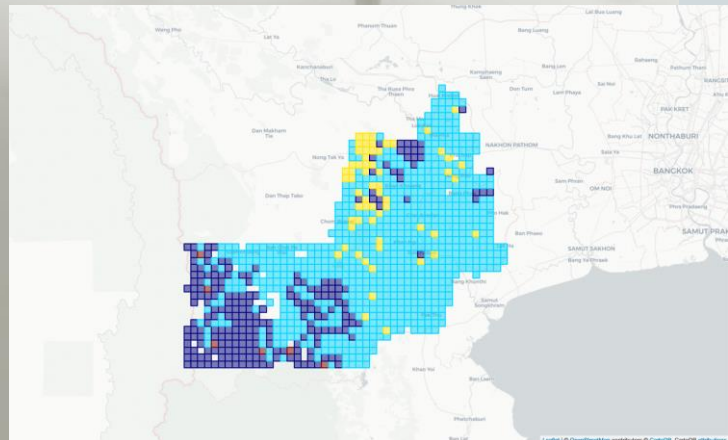

Mosquito abundance on a 2x2 km grid
Ratchaburi, Thailand

- ❑ After the model was established in Europe, in 2022 as part of the H2020 e-shape project the model was expanded to provide predictions for the *Aedes Aegypti* mosquito in Ivory Coast.
- ❑ In July the model provided the first predictions of entomological risk
- ❑ In the local Cocody-Bingerville health district in Côte d'Ivoire, that is the main foci of arboviruses (dengue, yellow fever, Zika, etc.) the predictions for *Aedes aegypti* mosquito abundance have been shared with the National Institute of Hygiene in the charge of National Arbovirus Programme and are being directly informed on any increase in arbovirus risk.
- ❑ The predictions were used to sensitize the local communities about the upcoming abundance of *Aedes* vectors and possible increase in arboviral transmission risk, and this have improved the adherence of the target communities with the project.
- ❑ Finally as a new expansion step the model trained in Ivory Coast has been transferred in Thailand to predict the *Aedes Aegypti* populations using transfer learning due to the lack of in-situ entomological data.

Visualization of the per decade expected increase in mosquito populations, 2020-2100, Veneto, Italy



RCP 2.6

Mosquito populations are expected to increase to a maximum of 6.5% in the 2080s compare to 2010s baseline.



RCP 4.5

Mosquito populations are expected to increase to a maximum of 10% in the 2080s compare to 2010s baseline.

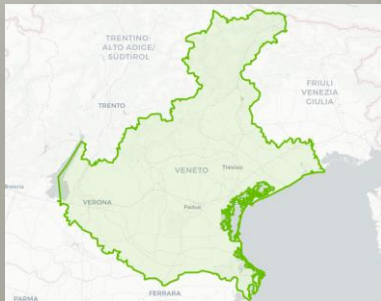

RCP 8.5

Mosquito populations are expected to increase to a maximum of 41%! in the 2090s compare to 2010s baseline.

Climate Change

- ❑ Research was conducted into how climate change is going to affect the mosquito populations in the current century.
- ❑ The **Land Surface Temperature** and **Rainfall** are among the most important features in the MAMOTH model according to the feature importance metrics.
- ❑ Using leading research into climate change projections the **Representative Concentration Pathway (RCP)** trajectory which is adopted by the **Intergovernmental Panel on Climate Change** was selected as the best fit for the work.
- ❑ These projections have been generated by the panel using an consistent set of socioeconomic assumptions, and provide different scenarios of emissions and the expected change in mean temperature and rainfall.
- ❑ The selected scenarios are:
 - **RCP 2.6:** Extreme measures are taken to reduce CO2 emissions which start declining by 2020 and fall to 0 by 2100.
 - **RCP 4.5:** Some measure are taken and CO2 emissions peak at 2040 then start declining to reach half the levels of 2050, in 2100.
 - **RCP 8.5:** No measures are taken and CO2 emissions continue to increase through 2100.
- ❑ The projected values for the Temperature and Rainfall from each scenario are adjusted by adding the changes into the input data which are then fed into the MAMOTH model and predictions are generated for the future.
- ❑ For the Veneto region which is one of the study areas, the expected population changes are for each scenario:
 - **RCP 2.6:** a maximum of 6.5% increase in population numbers is expected in the 2080s decade compared to the 2010s baseline.
 - **RCP 4.5:** a maximum of 10% increase in population numbers is expected in the 2080s decade compared to the 2010s baseline.
 - **RCP 8.5:** a maximum of 41%! increase in population numbers is expected in the 2090s decade compared to the 2010s baseline.

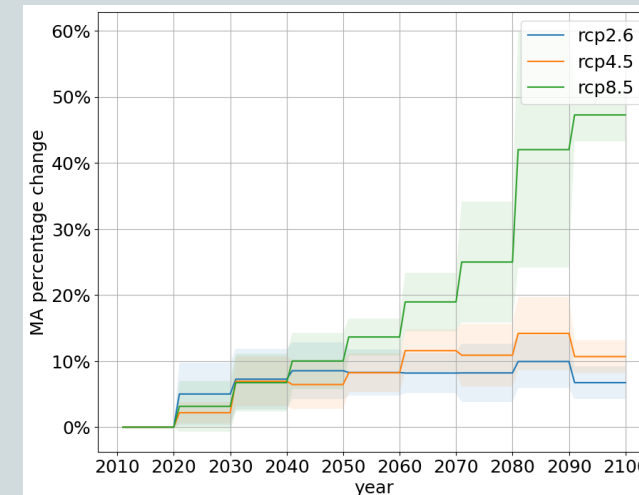

In Summary

- ❑ **EYWA** set the stage for the creation of a **truly big unique databases**
- ❑ Enabled the creation of **advanced data-driven & deterministic models** for mosquito abundance & risk mapping.
- ❑ The system keeps **expanding each year to new regions** with different climatic & socioeconomic conditions incorporating more data.
- ❑ Risk models provide **true early warning** from the beginning of the mosquito season, and guide targeted peri-urban larviciding actions on a settlement level
- ❑ MAMOTH model enabled the **coverage of a large number of regions worldwide**, providing support of entomological risk.
- ❑ Finally work with the climate change help relevant stakeholders and decision makers map the **future climatic prospects and risks**

Thank you!



Contact us

kontoes@noa.gr

(Coordinator of EuroGEO Action Group for Epidemics)
(Lead Partner of EYWA)

15 Partners | 5 Countries

Greece

National Observatory of Athens (NOA) – BEYOND Centre of EO
Research & Satellite Remote Sensing

Ecodevelopment S.A

University of Patras – Physics Department - Laboratory of
Atmospheric Physics (LapUP)

Dimitrios Vallianatos (IDCOM)

Aristotle University of Thessaloniki

University of Thessaly, Medical School. Laboratory of Hygiene and
Epidemiology

Italy

Istituto Zooprofilattico Sperimentale delle Venezie (IZSVe)

Edmund Mach Foundation

University of Trento

Serbia

University of “Novi Sad”, Faculty of Agriculture, Laboratory for
Medical and Veterinary Entomology

Scientific Veterinary Institute “Novi Sad”

University of Novi Sad, Faculty of Medicine

Germany

German Mosquito Control Association (KABS)

Bernhard Nocht Institute for Tropical Medicine

France

EID Méditerranée